



7000 Series

Door furniture & deadbolts



Outstanding quality coupled with a wide range of lever styles exquisitely finished in the rich tones of satin stainless steel are the key features of the Schlage 7000 Series. This contemporary lever range has a distinctively European feel. Blending form with function, the Schlage 7000 Series will allow you to express your individuality with lasting integrity. Beautifully designed down to the last detail, this series is manufactured from high quality stainless steel for high performance, increased durability, good looks and great feel.

The Schlage 7000 Series has a round rose with range of solid levers to choose from.

Features

- Constructed of quality components with solid stainless steel levers and outer roses
- Built in privacy push-button for quick installation and ease of use
- The 7000 Series is suitable for use on approved fire core door assemblies when used with fire rated mortice locks or latches
- Through bolts provide secure fixing, concealed by a round rose cover for aesthetic appeal

Specification guide





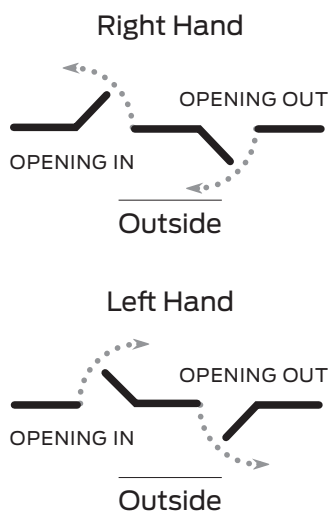

Function	Lever	Finish
Dummy trim7002	Albo713	Satin stainless steel SSS
Latch furniture 7000	Angelo714	
Passage set7005	Costa717	
Privacy set 7006	Dali712	
	Fattori704	
	Katz710	
	Vargas701	
	Vinci702	

- 1. Function**
 Select the desired function e.g. Passage set 7005/
- 2. Lever**
 Select the required lever design e.g. Angelo #714 7005/714
- 3. Finish**
 Select the desired finish e.g. Satin stainless steel 7005/714SSS

Handing guide



Specifications	
Door type	Timber or metal
Door thickness	Latch furniture 35mm to 50mm Passage set 35mm to 50mm Privacy set 32mm to 42mm
Backset	60mm or 70mm
Spindle size	7.6mm
Compatible locks/ latches	Tubular latches, ME Series mortice locks 990MF Series mortice locks
Fixing	Concealed through fixings
Materials	Solid stainless steel handles, die cast roses
Finish	Satin stainless steel
Warranty	10 year mechanical and finish when used on residential applications

Functions	Outside	Inside
7002 - Dummy trim Inactive lever which is used as a door pull or matching trim		
7000 - Latch furniture Two levers to be used with a latch, mortice lock or converted to dummy trim with fixing kit		
7005 - Passage set (60mm or 70mm backset) Both levers always unlocked		
7006 - Privacy set (60mm or 70mm backset) Push-button locks outside lever (outside emergency release). Inside lever unlocks door		

7000 Series solid stainless steel lever designs

Albo #713

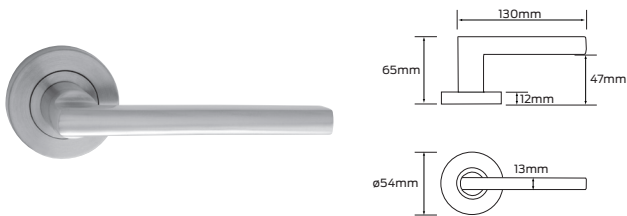

Angelo #714

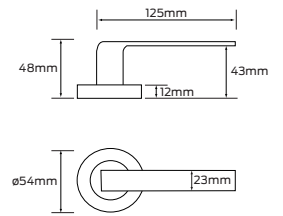

Costa #717



Dali #712

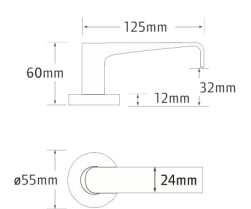

Fattori #704

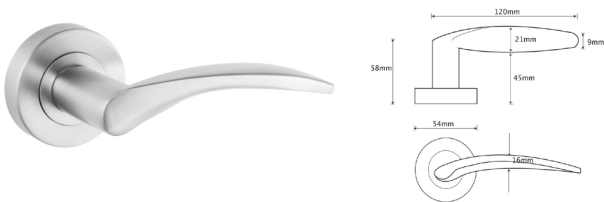

Katz #710

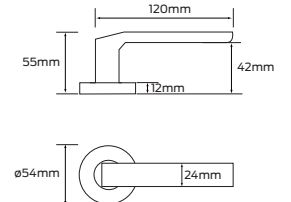

Vargas #701



Vinci #702

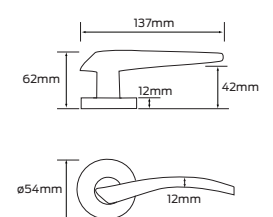

Passage door preparation

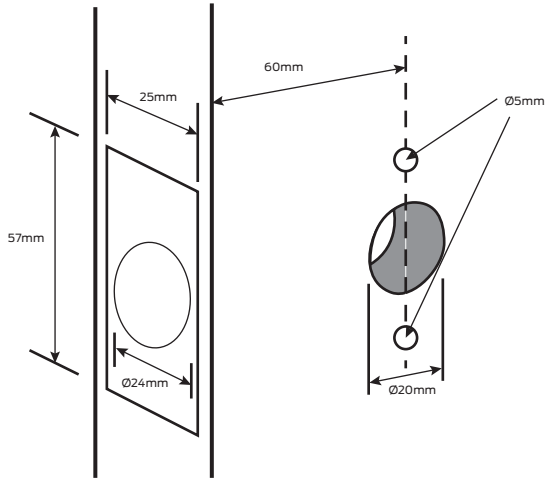

Privacy door preparation

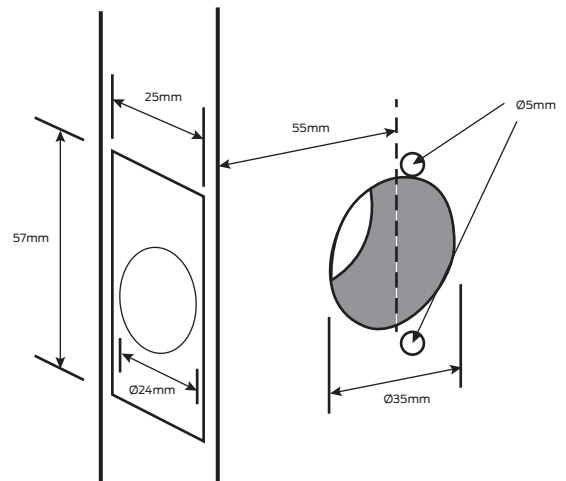

7000 Series escutcheons

Turn #7007



Cylinder #7008

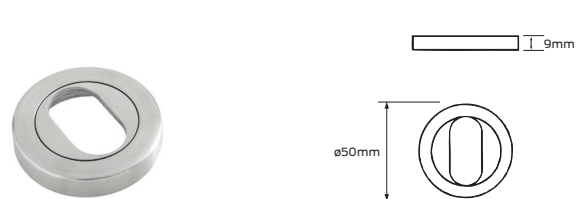

Emergency release #7009

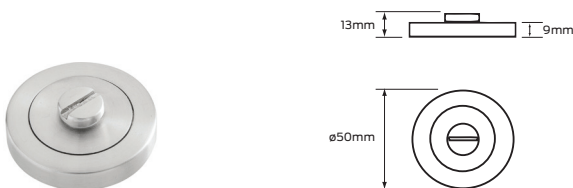

Accessible turn #7054

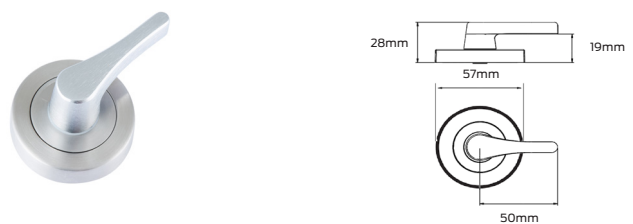

7000 Series escutcheons

Euro profile cylinder #7012

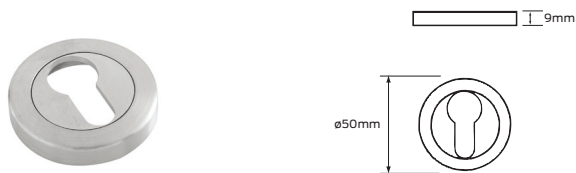

Indicating turn #7013



Indicating emergency release #7014

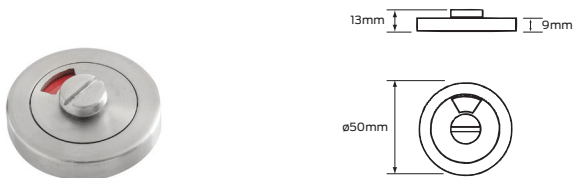

Indicating accessible turn #7054IND

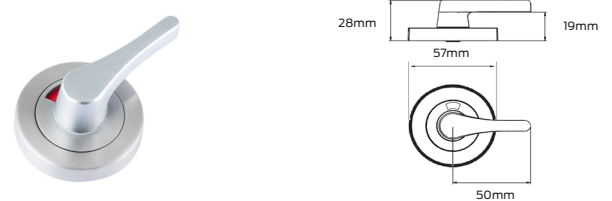

7000 Series accessories

Passage latch

60mm backset
Finishes: Chrome plate, satin chrome plate

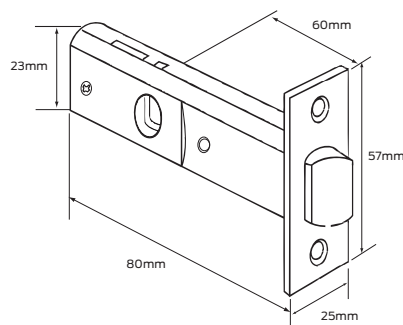

Privacy latch

60mm backset
Finishes: Chrome plate, satin chrome plate

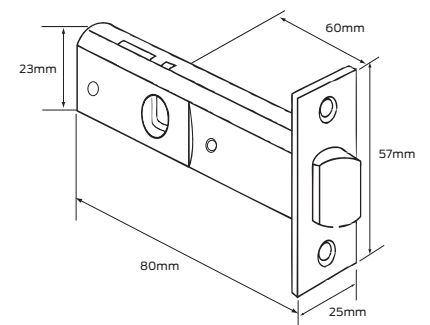

Dummy trim fixing kit

Allows conversion of lever furniture to dummy trim function.
 One kit required per lever



Rose caps

Available to mix and match finishes with levers
Finish: Satin stainless steel

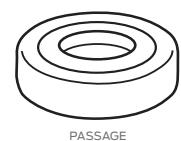

7000 Series accessories

Universal rebate kit

Finish: Satin chrome plate

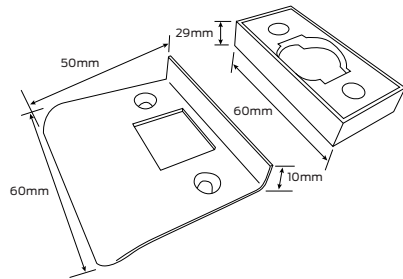

Emergency turn set

Turn escutcheon, emergency release escutcheon and deadbolt
Finish: Satin stainless steel

